

# 560.50











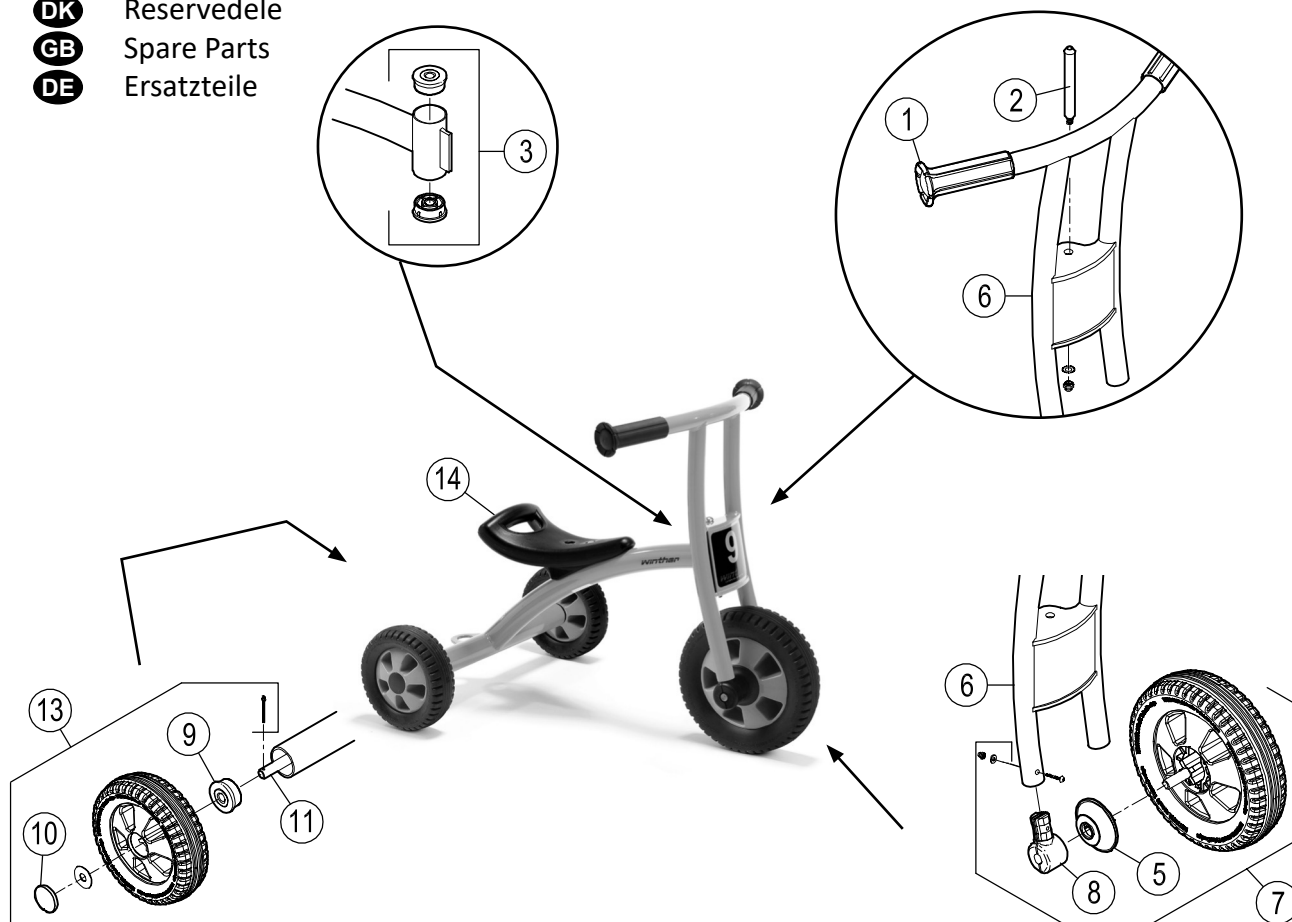







EN 71

ASTM F963



- DK** Reservedele
- GB** Spare Parts
- DE** Ersatzteile

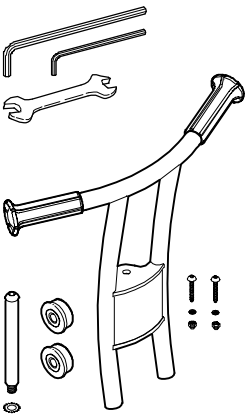
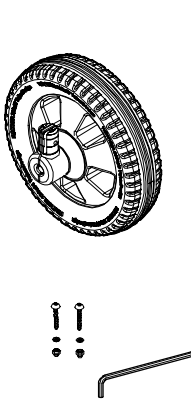
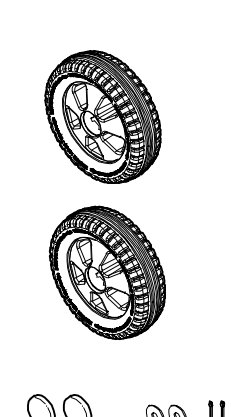
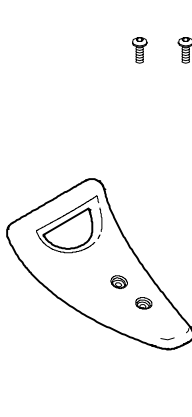

Pos.		Pos.	
1	 x2	8	 x2  x2  x1
2	 x1  x2  x1  x1  x1	9	 x2
3	 x2	10	 x2
4		11	 x1  x2  x2
5	 x2	12	
6		7	
13		14	

# 560.50



EN 71

ASTM F963



- DK** Reservedele
- GB** Spare Parts
- DE** Ersatzteile

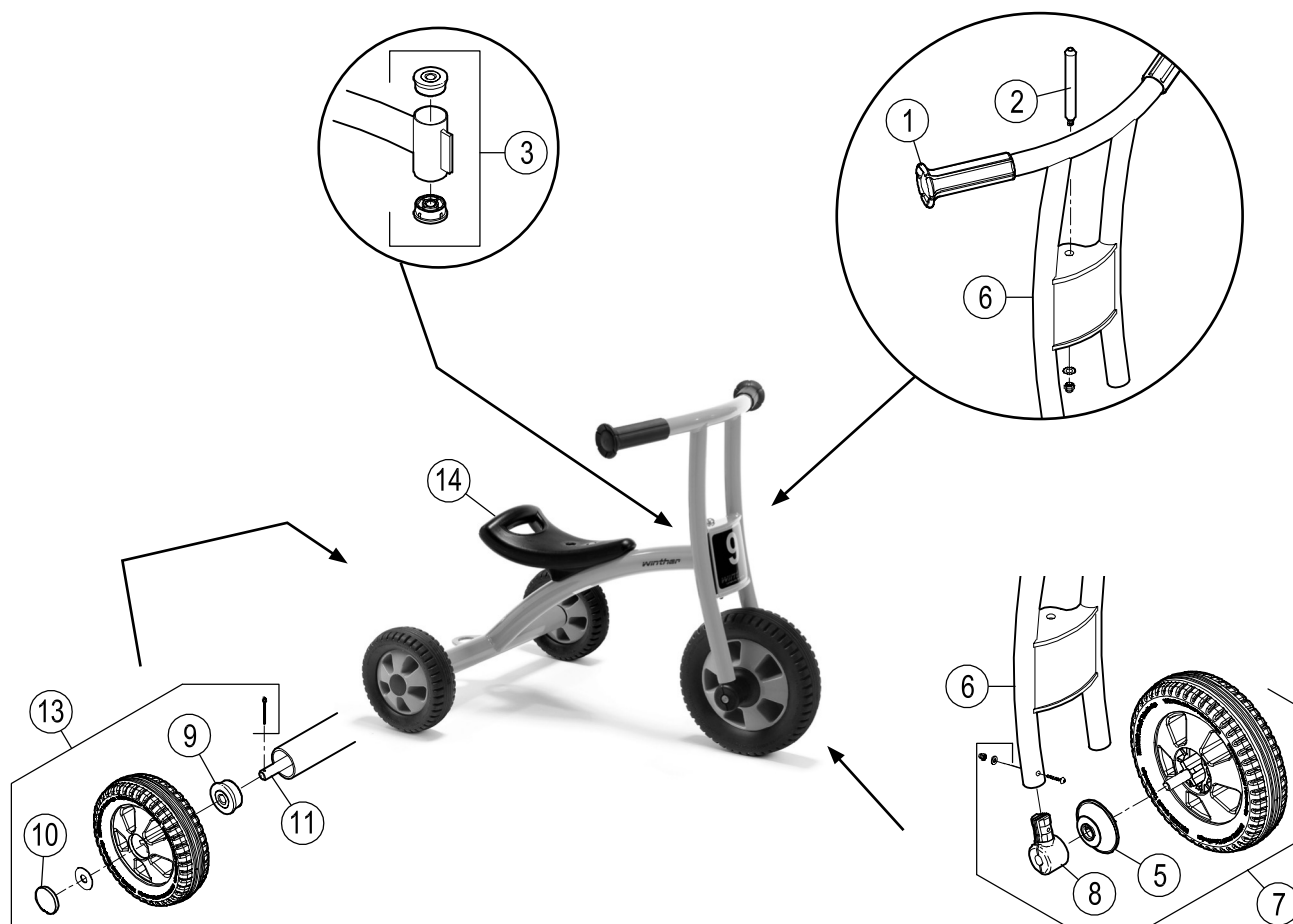

560.50					
Version					
Pos.	1.0				
1	50403				
2	50401				
3	50404				
4	-				
5	50270				
6	50450				
7	50280				
8	50406				
9	50418				
10	50285				
11	50291				
12	-				
13	50286				
14	50480				
15	-				

